

## Smiths Medical Publications

This publication has been compiled and approved by Smiths Medical for use with their respective products. It is supplied in this format to permit users to access the text and illustrations for their own use e.g. training and educational purposes.

Users of the equipment must ensure that they have read and understood the contents of the complete manual including the warnings and cautions and have been trained in the correct use of the product.

Smiths Medical cannot be held responsible for the accuracy and any resulting incident arising from information that has been extracted from this publication and compiled into the users documentation.

This publication maybe subject to revision and it is the users responsibility to ensure that the correct version of manual/text/illustration is used in conjunction with the equipment.

ACCEPT

REJECT

# smiths

**Smiths Medical MD, Inc.,**

1265 Grey Fox Road, St. Paul, MN 55112, U.S.A.

European representative:

**Smiths Medical International Limited**

Watford, Herts, UK, WD24 4LG

[www.smiths-medical.com](http://www.smiths-medical.com)

© 2005 Smiths Medical family of compaines. All rights reserved.

**smiths**

Smiths Medical - A part of Smiths Group plc

# Graseby MS 16A and MS 26 Syringe Driver

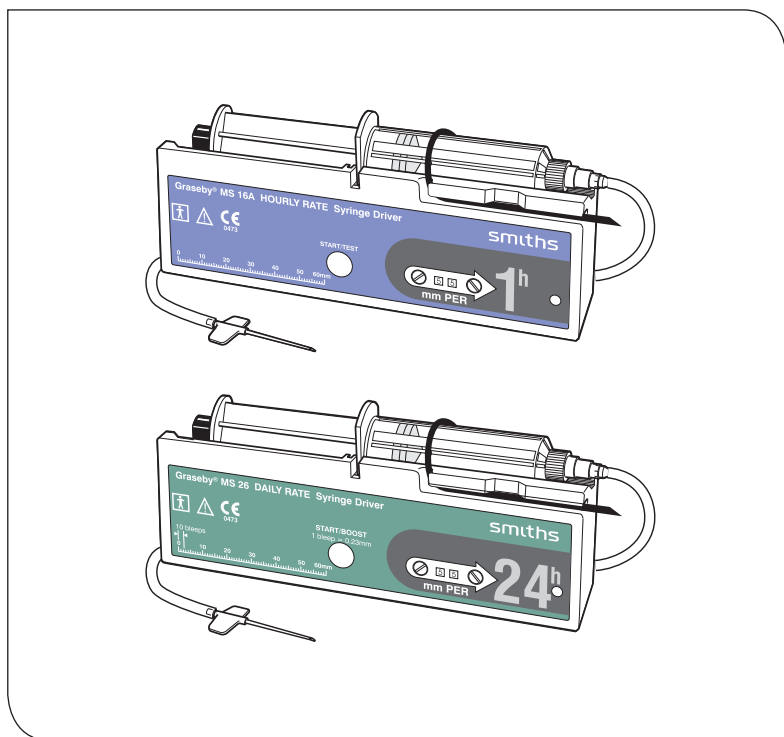

## Instruction Manual

smiths medical

Published by Smiths Medical MD, Inc.

All possible care has been taken in the preparation of this publication, but Smiths Medical accepts no liability for any inaccuracies that may be found.

Smiths Medical reserves the right to make changes without notice both to this publication and to the product which it describes.

© 2008 Smiths Medical family of companies. All rights reserved.

No part of this publication may be reproduced, transmitted, transcribed, or stored in a retrieval system or translated into any human or computer language in any form or by any means without the prior permission of Smiths Medical.

Smiths Medical MD, Inc.  
1265 Grey Fox Road, St. Paul, MN 55112, U.S.A.

European Representative:  
**Smiths Medical International Limited**  
Watford, Hertfordshire, UK, WD24 4LG

Registered in England.  
Company number 362847

**Trademarks and acknowledgements:**

Graseby and the Smiths design mark are a trademarks of the Smiths Medical family of companies. The symbol ® indicates the trademark is registered in the U.S. Patent and Trademark office and certain other countries.

All other names and marks mentioned are the trade names, trademarks or service marks of their respective owners.

# Contents

|  |           |
|--|-----------|
| <b>Warnings/ Caution .....</b>   | <b>3</b>  |
| <b>1 Instructions for the Graseby MS 16A and MS 26 Syringe Drivers .....</b> | <b>7</b>  |
| Product Literature .....   | 7         |
| Pack contents .....  | 7         |
| Introduction .....   | 7         |
| What is a Syringe Driver? .....  | 8         |
| What are the differences between a Graseby MS 16A and MS 26<br>Driver? ..... | 8         |
| Why are there two models? .....  | 9         |
| How to use the Syringe Driver .....  | 9         |
| Do's and Don'ts .....  | 9         |
| Fitting the battery .....  | 10        |
| What the controls do .....   | 11        |
| What the symbols on the Syringe Driver mean .....                            | 12        |
| Selecting a syringe .....  | 13        |
| Identifying the model, Graseby MS 16A or MS 26 Syringe Driver .....          | 13        |
| Setting the correct rate for the Graseby MS 16A .....                        | 14        |
| Setting the correct rate for the Graseby MS 26 .....                         | 16        |
| Notes on setting up your Syringe Driver .....                                | 18        |
| Fitting the syringe .....  | 18        |
| Fitting the cover .....  | 19        |
| Using the lockbox .....  | 20        |
| Starting the Syringe Driver .....  | 21        |
| During the administration .....  | 22        |
| How to use the Boost Dose on the Graseby MS 26 .....                         | 22        |
| Stopping the Syringe Driver .....  | 23        |
| Alarms .....   | 23        |
| Accessories .....  | 24        |
| Care and Maintenance .....   | 25        |
| Battery replacement .....  | 25        |
| Cleaning .....   | 26        |
| Storage .....  | 26        |
| Servicing .....  | 26        |
| Disposal .....   | 26        |
| Troubleshooting .....  | 28        |
| <b>2 Guide to subcutaneous analgesia .....</b>                               | <b>29</b> |
| Parenteral administration of drugs .....                                     | 29        |
| Indications .....  | 29        |
| Converting from oral to parenteral administration .....                      | 29        |
| Drugs commonly administered using syringe drivers .....                      | 29        |
| What is needed for a subcutaneous infusion with the<br>Syringe Driver? ..... | 30        |
| Selection of a suitable infusion site .....                                  | 31        |
| Inserting the Subcutaneous Needle .....                                      | 31        |
| Observation during treatment .....   | 31        |
| <b>3 Technical and Performance Specification .....</b>                       | <b>32</b> |
| Standards .....  | 38        |



## Warnings/ Cautions

### Warnings

Warnings tell you about dangerous conditions that could lead to death or serious injury to the user or patient, which can occur if you do not obey all the instructions in this manual.

- 1. WARNING:** Always ensure that the correct driver is being used for the infusion. The Graseby MS 16A Syringe Driver is for hourly rate infusions between 30 minutes and 24 hours and has a blue label. The Graseby MS 26 Syringe Driver is for daily rate infusions of 1 day or longer and has a green label. Failure to use the correct model driver may result in an inaccurate delivery of medication, resulting in patient injury or death.
- 2. WARNING:** To avoid incorrect or inappropriate infusion volumes, the correct rate may only be set by qualified persons or authorised personnel. Incorrect rate settings could lead to an inappropriate infusion resulting in patient injury or death.
- 3. WARNING:** In order to ensure that the intended infusion is performed, the rate must be entered correctly. Failure to do so may result in compromised function of the product, patient injury or death.
- 4. WARNING:** This equipment is not suitable for use in the presence of flammable anaesthetic mixtures with air, oxygen, or nitrous oxide. The use of the device in presence of such mixtures may lead to explosion or fire.
- 5. WARNING:** To avoid possible malfunction of the driver, do not expose the driver to X- rays, gamma rays or ionizing radiation, or to the RF interference or strong electric/ magnetic fields emitted (for example) by diathermy equipment or mobile telephones. If the driver is used in the presence of, or in combination with Magnetic Resonance Imaging (MRI) machines it must be protected from the magnetic field emitted by such equipment. Malfunction of the pump can cause incorrect infusion or loss of infusion resulting in patient injury or death.
- 6. WARNING:** Operation of the driver outside the temperature limits defined in the Specification may result in erroneous operation. Ensure that the temperature is within the specified limits. Failure to do so may result in patient injury or death.
- 7. WARNING:** The driver may only be opened by a suitably qualified engineer. Unauthorised modifications may result in the compromised functioning of the driver, leading to patient or user injury or death.
- 8. WARNING:** Failure to follow the Maintenance and Test Procedures described the Graseby MS 16A and MS 26 Syringe Driver Technical Service Manual may result in compromised function of the product and lead to patient injury or death.
- 9. WARNING:** It is essential that the visual and audible alarms on the driver are not obscured so that all alarms are responded to promptly. Failure to respond promptly to an alarm may result in patient injury or death.
- 10. WARNING:** The user should ensure that the performance offered by the driver is fit for the intended purpose. Failure to do so may result in compromised function of the product, patient injury or death.
- 11. WARNING:** Do not use a faulty driver. If the driver detects a fault, a 15 second alarm will sound. If this happens, the driver must not be used until a suitably qualified engineer has tested and rectified the fault. Incorrect performance of the driver can cause complications resulting in patient injury or death.
- 11. WARNING:** Ensure that the correct battery type is fitted, correctly installed and with adequate charge for the infusion. Failure to do so may lead to impaired functioning of the driver, resulting in patient injury or death.

**12. WARNING:** Use only a syringe within the range specified in the Technical and Performance Specifications at the end of this manual. Failure to do so may result in an inaccurate delivery. Smiths Medical does not guarantee performance of the driver if syringes other than those listed are used. Incorrect function or performance of the driver can cause complications resulting in patient injury or death.

**13. WARNING:** Do not move the driver between extremes of humidity. Condensation may form inside the driver, resulting in the incorrect function or performance of the driver which may cause complications resulting in patient injury or death.

**14. WARNING:** The volume of fluid contained in the connecting tubing is a residual amount and will not be infused. Allowance must be made for this extra volume of fluid when initially filling the syringe and purging the system. Under-delivery of medication can cause complications resulting in patient injury or death.

**15. WARNING:** To avoid patient embolism, ensure that the patient tubing is purged of all air bubbles before administering any medication. The presence of air within the medication can result in complications leading to patient injury or death.

**16. WARNING:** For safe operation of the driver, the syringe must be correctly loaded. Ensure that the syringe plunger is properly aligned before tightening the securing strap. Failure to do so may result in inaccurate delivery, resulting in patient injury or death.

**17. WARNING:** To avoid syphoning of the syringe contents (free flow), ensure that the syringe is correctly loaded into the driver, that the syringe plunger is properly engaged by the driver's actuator and that the driver is placed not more than 80 cm above the infusion site. Syphoning can result in over-infusion leading to patient injury or death.

**18. WARNING:** To avoid over-infusion, do not purge the infusion line when the administration set is connected to the patient. Over-infusion of medication can result in patient injury or death.

**19. WARNING:** Only use the driver if the rubber securing strap is correctly positioned over the syringe and firmly hooked in place. An incorrectly secured driver may cause an uncontrolled delivery of infusate to the patient, resulting in patient injury or death.

**20. WARNING:** When not used as an ambulatory driver, ensure that the driver is stable and secure and that the syringe is on the top of the driver and horizontal. The Non-slip Base should be used and placed on an horizontal surface. Failure to observe this warning may cause damage to the driver and harm the patient. As a result, the patient may suffer direct injury, or the driver may fail to operate correctly, leading to patient injury or death.

**21. WARNING:** When used in an ambulatory mode, the driver must be secured within the holster with the clear, rigid plastic cover fitted. Failure to do so may result in compromised functioning of the pump, leading to patient or user injury or death.

**22. WARNING:** To prevent the driver being tampered with, the driver must be locked in the Graseby Lockbox. The key must be held by an authorised person. Failure to do so may result in misuse of the pump, leading to patient or user injury or death.

**23. WARNING:** Following a significant liquid spill onto the driver or the Lockbox, it should be withdrawn from use, wiped dry and inspected and tested by service personnel before being returned to service. Failure to do so may result in compromised functioning of the driver, leading to patient or user injury or death.

**24. WARNING:** To avoid syphoning of the syringe contents (free flow), ensure that the patient line is clamped before loading or unloading the syringe. Syphoning can result in over-infusion leading to patient injury or death.

**25. WARNING:** When the driver is used in a Lockbox, the alarm volume may be moderately reduced. Failing to hear and respond to the alarm may result in patient injury or death.

**26. WARNING:** When the driver is used in a Lockbox, ensure that tubing is not trapped or kinked. Misdelivery of medication can cause complications resulting in patient injury or death.

## Cautions

Cautions tell you about dangerous conditions that may occur and cause damage to the driver if you do not obey all of the instructions in this manual.

**1. CAUTION:** Do not use cleaning and disinfecting agents other than the approved ones specified here. Agents not approved may damage the driver.

**2. CAUTION:** Do not immerse either the driver or the Lockbox in any liquids or expose them to strong organic solvents. Wipe off spills immediately, and do not allow fluid or residues to remain. Additionally, the driver and Lockbox are not designed to be autoclaved, steam-sterilised, EtO-sterilised or subjected to temperatures in excess of 45° C (113° F). Failure to observe this caution may cause serious damage to the driver.

**3. CAUTION:** Always use the correct type and size of battery. The driver may be damaged if an attempt is made to fit an incorrect size battery.



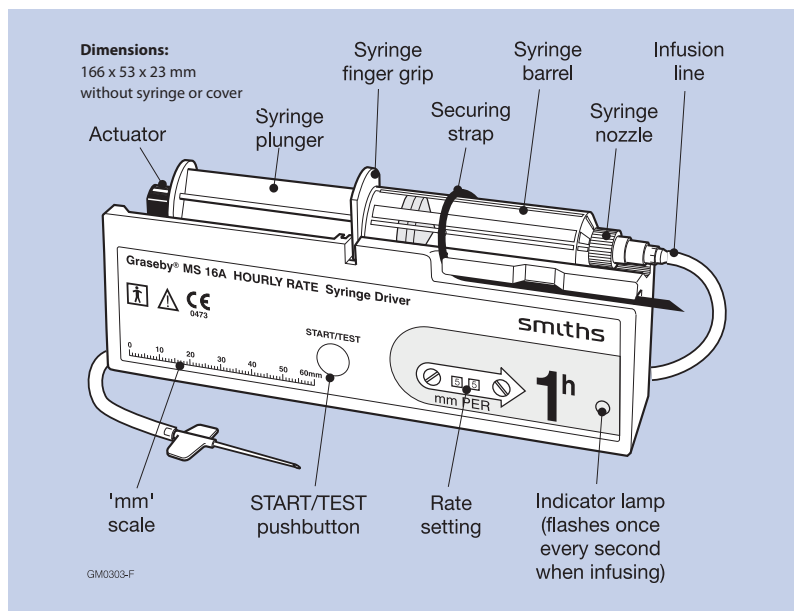

The Graseby MS 16A HOURLY RATE Syringe Driver

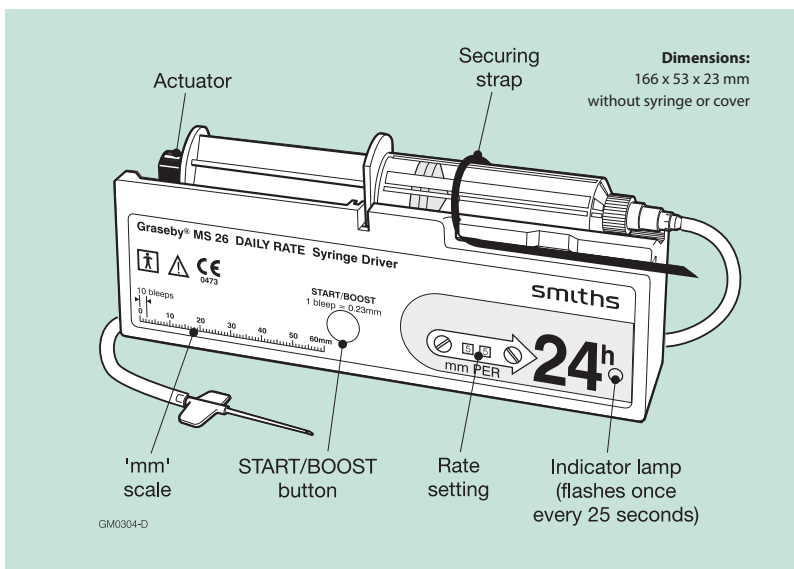

The Graseby MS 26 DAILY RATE Syringe Driver

# 1 Instructions for the Graseby MS 16A and MS 26 Syringe Drivers

**WARNING: These instructions contain important information for safe use of the product. Read the entire contents of these Instructions For Use, including Warnings and Cautions, before using the Graseby MS 16A and MS 26 Syringe Drivers. Failure to properly follow warnings, cautions and instructions could result in death or serious injury to the patient.**

## Product Literature

The Instruction manual, part number 0105-0549 is supplied with the Graseby MS 16A and MS 26 Syringe Drivers. Other product literature includes:

- MS 16A Technical service manual - part number OOSM-0106
- MS 26 Technical service manual - part number 00SM-0113

The Instruction manual is also available in the following languages:

- French, German, Greek, Italian, Spanish and Swedish

## Pack contents

MS 16A Syringe Driver - packed set, part number 0105-0504

MS 26 Syringe Driver - packed set, part number 0113-0001

Each pack contains the following items:

- Syringe Driver
- Syringe cover (clear plastic)
- Syringe holster (fabric)
- Rate adjuster
- Instruction manual
- Battery, type MN1604

## Introduction

This manual contains instructions on how to use and care for the Syringe Driver safely, and what to do if it should go wrong. Please take time to read all the information before you start to use the Syringe Driver; follow all warnings printed in bold type.

The Syringe Driver is a medical device designed and made to achieve a high level of safety protection. Before using the Syringe Driver, refer to the performance specification to ensure suitability for the treatment. Incorrect use could result in patient injury or death.

The Syringe Driver must only be used under the supervision of a medical professional.

Please ensure that a copy of this Instruction Manual is given to the person responsible for using the Syringe Driver.

**WARNING: To avoid incorrect or inappropriate infusion volumes, the rate may only be set by qualified persons or authorised personnel. Incorrect rate settings could lead to an inappropriate infusion resulting in patient injury or death.**

## What is a Syringe Driver?

A Syringe Driver is a power driven device for pushing the plunger of a syringe forward at an accurately controlled rate. It is an aid in administering medicinal preparations in liquid form over much longer periods than could be achieved by injecting by hand.

A suitable sterile syringe with a sterile pathway is also required to deliver medication to the patient.

**The Graseby MS 16A and MS 26 Syringe Drivers** are both non-sterile devices. They are battery powered ambulatory devices, that can be carried by patients whilst undergoing treatment.

The Syringe Drivers are suitable for administering medication intravenously (IV) or subcutaneously. For more information on subcutaneous infusion therapy, see the section **Guide to subcutaneous analgesia**.

A driver may be reused if it is in good condition and has been regularly tested and maintained.

## What are the differences between the Graseby MS 16A and MS 26 Syringe Drivers?

It is most important to be familiar with what the differences are. The most visible difference is the colour; the **MS 16A** has a **blue** label and the **MS 26** a **green** one.

The table shows all the main differences:

| Feature                      | MS 16A HOURLY RATE                   | MS 26 DAILY RATE                     |
|------------------------------|--------------------------------------|--------------------------------------|
| Rate range                   | 0 - 99 mm per hour                   | 0 - 99 mm per 24 hours               |
| Indicator lamp flashes every | 1 second                             | 25 seconds                           |
| Motor turns every            | $(420 \div \text{rate set})$ minutes | $(168 \div \text{rate set})$ minutes |
| Test time                    | 5 seconds                            | 10 seconds                           |
| Boost                        | NO                                   | YES                                  |
| Label colour                 | Blue                                 | Green                                |

**WARNING: Always ensure that the correct driver is being used for the infusion. The Graseby MS 16A Syringe Driver is for hourly rate infusions between 30 minutes and 24 hours and has a blue label. The Graseby MS 26 Syringe Driver is for daily rate infusions of 1 day or longer and has a green label. Failure to use the correct model driver may result in an inaccurate delivery of medication, resulting in patient injury or death.**

## Why are there two models?

The **MS 16A** is intended for administrations lasting between 30 minutes and 24 hours. The rate setting is in millimetres (mm) of syringe plunger movement every hour. The **MS 16A** is known as the **HOURLY RATE** Syringe Driver.

For slower infusions, the **MS 26** is intended for administrations over periods of 1 day and longer. The rate setting is in millimetres (mm) of syringe plunger movement every 24 hours. The **MS 26** is known as the **DAILY RATE** Syringe Driver. At the slowest setting, of **01**, the **MS 26** would take 60 days to move the actuator over the full length of travel. The **MS 26** can also be used to give manually administered boost doses during the administration.

## How to use the Syringe Driver

### Do's and Don'ts

- DO check the battery daily.
- DO avoid using mobile telephones close, nearer than 1 metre, to the Syringe Driver. Although there have been no confirmed reports of mobile telephones interfering with the operation of the Syringe Driver, following this advice will help reduce any risk.
- DON'T use the Syringe Driver without understanding these instructions.
- DON'T get it wet. It is not waterproof, even when enclosed in a Lockbox, and the performance will be affected.
- DON'T take it from a cool environment and put it into a warm, very humid environment (e.g. an incubator) or take it from there into a cooler one. Condensation will form and the inside will get wet.
- DON'T use the Syringe Driver without understanding these instructions.
- DON'T take it from a cool environment and put it into a warm, very humid environment (e.g. an incubator) or take it from there into a cooler one. Condensation will form and the inside will get wet.
- DON'T open it up to look inside. The performance will be affected.
- DON'T use it in or near strong magnetic fields, Nuclear Magnetic Resonance (NMR) scanners for example. They may stop it.
- DON'T use it in the presence of flammable anaesthetic gases or in an oxygen enriched atmosphere. It may increase the risk of a fire or explosion.
- DON'T use it outside its temperature range. The performance will be affected.
- DON'T wipe it with organic cleaning solvents or strong disinfectants. The plastic case may be damaged.

## Fitting the battery

Always fit a 9 volt (9V) 'alkaline' battery. Alkaline batteries can be identified by the international code 6LR61 marked on them or on their packaging. They are available from most retail outlets selling batteries. A recommended battery of this type is the DURACELL MN1604.

Be careful when selecting a battery as some brands may not fit properly. If possible, try the battery in the battery compartment first. Never try to force in a battery which is too large as this may damage the battery contacts.

Batteries of the 'zinc-carbon' type (marked 6F22 or 6R61), for example a PP3, are not recommended. They perform poorly with the Syringe Driver and need to be replaced more often.

To fit a battery:

1. Slide off the cover at the back of the Syringe Driver.
2. Push in the battery.  
The label in the battery compartment shows which way round to put it. Accidentally putting it in the wrong way round will not do any harm.
3. Slide the cover on again until it latches shut.

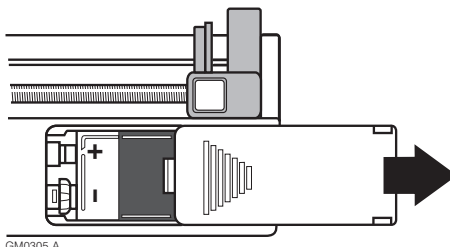

The alarm will sound for about 15 seconds after the battery is fitted.

To remove a battery, see page 25.

**CAUTION: Always use the correct type and size of battery. The driver may be damaged if an attempt is made to fit an incorrect size battery.**

## What the controls do

### Rate setting switches

These are the two switches that set the rate (speed) at which the syringe plunger will be pushed forwards. This is the distance, in mm, that the plunger will move in one hour on an **MS 16A** and in one day on an **MS 26**.

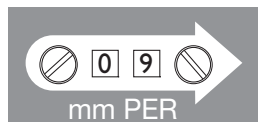

There is one switch for the 'tens' and one for the 'units' of the rate value. Values from **0** to **99** can be set. The numbers set appear in the windows next to each switch. The switches can be turned with the key supplied or with a small screwdriver with a flat blade.

**WARNING: The correct rate may only be set by qualified persons or authorised personnel. Incorrect rate settings could lead to an inappropriate infusion resulting in patient injury or death.**

**WARNING: In order to ensure that the intended infusion is performed, the rate must be entered correctly. Failure to do so may result in compromised function of the product, patient injury or death.**

### START/TEST button (MS 16A)

Pressing and holding this button down tests the safety system. Releasing it starts the MS 16A.

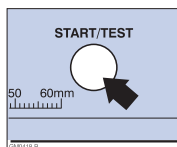

### START/BOOST button (MS 26)

Pressing and holding this button down tests the safety system and allows a boost dose to be administered by counting the sound beeps. Releasing it starts the MS 26.

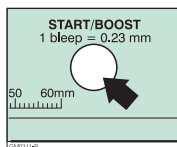

### Actuator release button

Pressing and holding this button down releases the actuator so it can be moved backwards or forwards by hand.

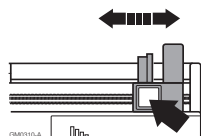

## What the symbols on the Syringe Driver mean



An electrical safety classification in the international safety standard for medical electrical equipment, Type BF. If the equipment is used as intended there is no risk of a serious electric shock. But it is not suitable for direct connection to the heart.



Refer to the accompanying instructions on how to use the equipment. The instructions are all in this manual.



Refer to page 34.



Refer to page 34.



Refer to page 34.

## Selecting a syringe

Most of the small sterile plastic syringes available, from 2 ml up to 35 ml capacity, can be used. Syringes with a Luer lock nozzle are best because they offer more security against accidental disconnection of the infusion line.

Choose a syringe brand and size that fits properly onto the Syringe Driver. The adjustable strap must fit round it to hold it firmly, the finger grip and the plunger push-button must fit in the retaining slots in the case and actuator.

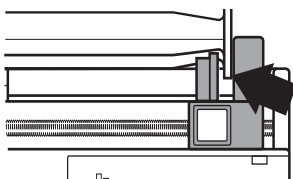
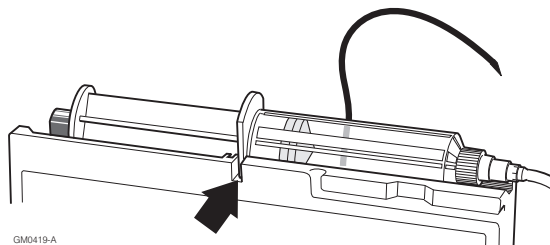

With some of the larger sizes it may not be possible to fill them to their full capacity BUT they can still be used as long as they fit on properly.

## Identifying the model - Graseby MS 16A or MS 26 Syringe Driver

The MS 16A is the **HOURLY RATE** model with the rate in mm per 1 h and has a **BLUE** label

The MS 26 is the **DAILY RATE** model with the rate in mm per 24 h and has a **GREEN** label.

**WARNING: For safe operation of the driver, the syringe must be correctly loaded. Ensure that the syringe plunger is properly aligned before tightening the securing strap. Failure to do so may result in inaccurate delivery, resulting in patient injury or death.**

**WARNING: Always ensure that the correct driver is being used for the infusion. The Graseby MS 16A Syringe Driver is for hourly rate infusions between 30 minutes and 24 hours and has a blue label. The Graseby MS 26 Syringe Driver is for daily rate infusions of 1 day or longer and has a green label. Failure to use the correct model driver may result in an inaccurate delivery of medication, resulting in patient injury or death.**



## Setting the correct rate for the Graseby MS 16A

1. Fill the syringe with the required volume of medication.
2. Connect and fill the infusion line. Make sure the connection is secure and the air is expelled.
3. Measure the distance, in millimetres (mm), from the empty (0) line on the syringe's scale up to the line where the plunger piston is. There is a 'mm' scale on the front of the MS 16A for this.
4. Divide this distance, measured in mm, by the time in hours (h) all the medication in the syringe needs to be administered in. The answer is the rate to set in the rate windows

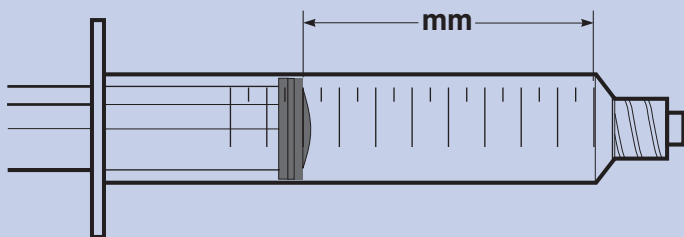

$$\text{Distance in mm} \div \text{Time in hours} = \text{Rate in mm per 1 h}$$



Here is an example:

A syringe is to be used to administer 8 ml of medication over 12 hours.  
With this syringe filled to the 8 ml line, the plunger travel measures 48 mm.

$$48 \text{ mm} \div 12 \text{ hours} = 4 \text{ mm per } 1 \text{ h}$$

Set the rate switches to **04**

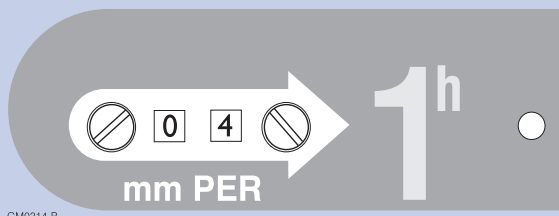

Each switch must be moved until all of the number can be seen in the window.

In this example, every hour the syringe plunger will move forwards 4 mm, administering about 0.67 ml of the medication and after 12 hours the syringe will have emptied.

Remember that for rates up to 9 the left-hand 'tens' number must be set at **0**.

If the result of the division is not a whole number select the nearest whole number for the rate.

**REMEMBER THAT YOU HAVE TO SET THE RATE IN MILLIMETRES (mm) NOT MILLILITRES (ml).**

## Setting the correct rate for the Graseby MS 26

1. Fill the syringe with the required volume of medication.
2. Connect and fill the infusion line. Make sure the connection is secure and the air is expelled.
3. Measure the distance, in millimetres (mm), from the empty (0) line on the syringe's scale up to the line where the plunger piston is. There is a 'mm' scale on the front of the MS 26 for this.

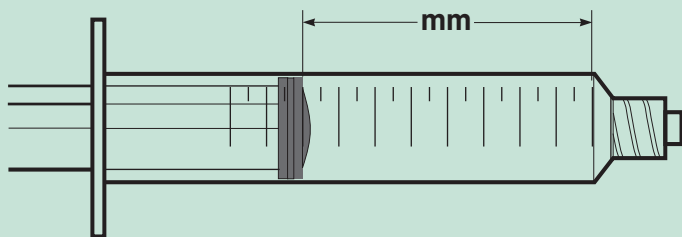

GM0313-A

4. Divide this distance, measured in mm, by the time in days (24 hour (h) periods) all the medication in the syringe needs to be administered in. The answer is the rate to set in the rate windows.

$$\text{Distance in mm} \div \text{Time in days} = \text{Rate in mm per 24 h}$$



Here is an example:

A syringe is to be used to administer 8 ml of medication over 2 days. With this syringe filled to the 8 ml line, the plunger travel measures 48 mm.

$$48 \text{ mm} \div 2 \text{ days} = 24 \text{ mm per 24 h}$$

Set the rate switches to **24**

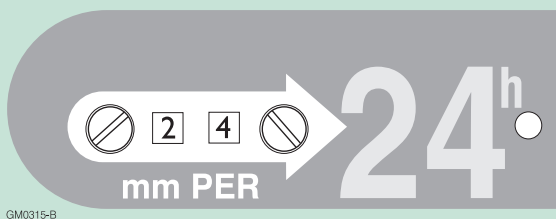

Each switch must be moved until all of the number can be seen in the window.

In this example, every 24 hours the syringe plunger will move forwards 24 mm, administering about 4 ml of the medication and after 48 hours the syringe will have emptied.

Remember that for rates up to 9 the left-hand 'tens' number must be set at **0**.

If the result of the division is not a whole number, select the nearest whole number for the rate.

**REMEMBER THAT YOU HAVE TO SET THE RATE IN MILLIMETRES (mm) NOT MILLILITRES (ml).**

## Notes on setting up your Syringe Driver

An alternative method may be used to set up the Graseby MS 16A or MS 26 Syringe Driver if a specific policy has been devised as part of your hospital/ community protocol.

The alternative method involves first measuring the volume in the syringe, then priming the line.

**Precaution: If you measure first, then prime the line, the infusion will finish early. You should therefore only use this method when your hospital has devised this protocol for a specific clinical area.**

## Fitting the syringe

1. Put the syringe on top of the Syringe Driver, with its barrel in the shallow V-shaped recess. The finger grip on the syringe barrel must be in the slot in the case.
2. Move the actuator up to the syringe plunger, by pressing and holding in the button on the side, and sliding it along. The push-button on the plunger of the syringe must be fitted in the slot in the actuator. Be careful not to push the plungers.
- 3.

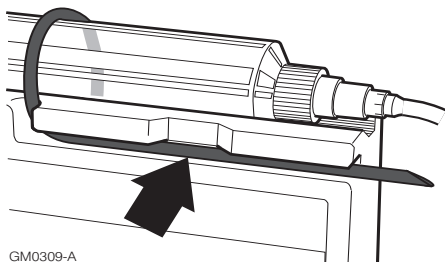

GM0309-A

**Older versions did not have the slot in the actuator for the syringe plunger push-button. A small metal screw-clamp was supplied and this must be fitted through the hole in the actuator and used to hold the plunger push-button. The actuator can be replaced by the latest type and it is recommended that this is done the next time the Syringe Driver is overhauled.**

4. Put the rubber securing strap over the syringe barrel and pull it tight. Hook and then press it into the groove in the side of the case.

**Precaution: Risk of uncontrolled flow into the patient. Only use the Driver if the syringe can be secured as described.**

**If the selected syringe does not fit, try another brand of syringe with the same capacity.**

**Precaution: The rate setting used may need to be changed so the dose is administered in the same time. Recalculate the correct rate to use.**

## Fitting the cover

The clear Cover is supplied to protect the Syringe Driver with a syringe fitted. If the Syringe Driver is to be put in a holster, this Cover must be used.

- Slide the Syringe Driver into one of the open ends of the Cover with the front facing the side of the Cover with the hole in it.  
**NEVER PUT THE SYRINGE DRIVER IN FACING THE OTHER WAY.**
- Push the Syringe Driver in until the START button lines up with the hole. The peg on the inside back of the Cover goes into the hole in the middle of the back of the Syringe Driver. It is now held in the Cover.

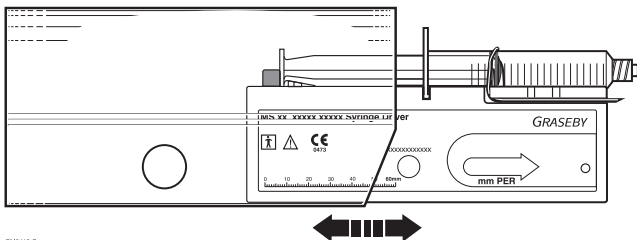

GM0102C

- The **START** button can be pressed through the hole in the Cover when needed.
- If the Syringe Driver is to be carried then the Holster can be used. Keeping the syringe nozzle uppermost, slide the Syringe Driver with its Cover into the Holster. Fasten the tape across the top to hold everything in. Make sure the infusion line is not trapped anywhere.

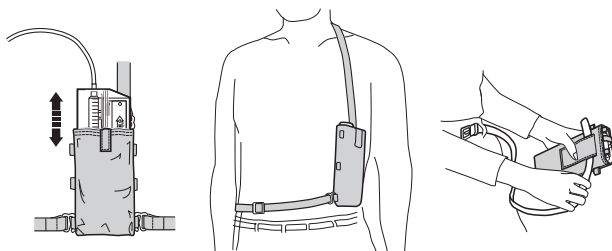

GM0316-A

- To remove the Syringe Driver from the Cover, hold the Cover without squeezing it and press firmly on either end of the Syringe Driver until it pops out.

## Using the lockbox

Secure protection for the Syringe Driver may be provided by using the shatterproof, translucent Lockbox.

The Lockbox gives total protection to the syringe Luer and minimises the risk of tampering with the syringe.

Clear windows at the top allow the user to check the syringe pusher and the syringe barrel. A window at the side provides a clear area for viewing the set rate.

The Lockbox fits snugly in the MS driver Shoulder Holster. It is stable when operating from a flat surface.

The Lockbox is an optional item (part number 0105-0640) and is supplied with operating instructions.

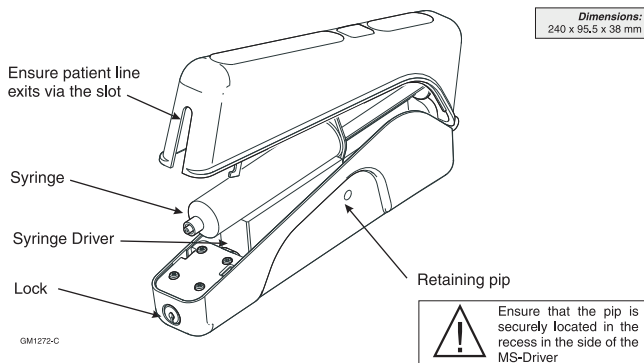

1. Unlock and open the Lockbox.
2. Position the syringe driver in the Lockbox as shown in the diagram.
3. Snap the retaining pip into place on the Syringe Driver.
4. Close the lid and lock the box, ensuring that the patient line exits via the slot.
5. To release the Syringe Driver from the Lockbox, open the lock, raise the cover and ease the side of the box away from the Driver until the retaining pip disengages. Lift out the Syringe Driver.

**WARNING: When the driver is used in a Lockbox, the alarm volume may be moderately reduced. Failing to respond to the alarm may result in patient injury or death.**

**WARNING: When the driver is used in a Lockbox, ensure that tubing is not trapped or kinked. Misdelivery of medication can cause complications resulting in patient injury or death.**

**WARNING: Following a significant liquid spill onto the driver or the Lockbox, it should be withdrawn from use, wiped dry and inspected and tested by service personnel before being returned to service. Failure to do so may result in compromised functioning of the driver, leading to patient or user injury or death.**

## Starting the Syringe Driver

Before starting the administration, go through this checklist to make sure everything has been set up correctly:

- Correct Syringe Driver is being used: MS 16A or MS 26.
- Valid brand and syringe size is fitted.
- Syringe is fitted securely.
- Syringe is filled with correct volume.
- Rate set is correct - check numbers showing in windows.
- Cover is fitted correctly (if needed).

Everything should now be ready to start. Always follow this start up procedure to check that the safety system and alarm are working.

1. Press and hold down the **START** button. The motor will turn and stop after:

5 seconds for an **MS 16A**

10 seconds for an **MS 26**

2. The alarm will sound. The alarm continues for about 15 seconds longer if the button is not released.

**Precaution: Do not use the Syringe Driver if the motor does not stop and/ or the alarm does not sound. Refer to the section on servicing for advice on what to do if this happens.**

3. Release the button to start the Syringe Driver.
4. The indicator lamp will begin to flash:

once a second  
on the **MS 16A**

once every 25 seconds  
on the **MS 26**

**Tip:** If the lamp does not flash, fit a new battery (see page 25).

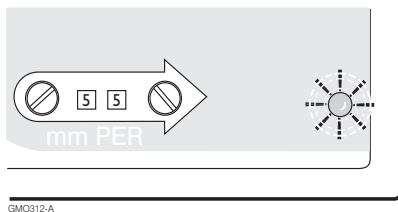

**Precaution: The patient will receive a small amount of medication as the syringe plunger is pushed forwards during the safety check. If this is undesirable, the final patient connection can be left until the START button has been released.**



## During the administration

It is recommended that procedures are established for regular checks on the progress of the administration. Patients, relatives or other carers, as well as medical staff, should be made aware of a few simple checks that can be made.

These are to confirm that:

- the volume is being delivered as expected,
- the rate set is the correct value,
- the indicator lamp is flashing (the battery is not exhausted),
- the Syringe Driver is in good condition.

Also that they know what to do and who to contact in an emergency.

## How to use the Boost Dose on the Graseby MS 26 Syringe Driver

To administer a small boost dose (bolus) of medication, the **START/BOOST** button can be pressed and the number of beeps of sound counted. With each beep, the syringe plunger moves forwards a controlled distance. Each beep is equivalent to 0.23 mm of plunger travel.

Here is an example:

The MS 26 has been set up to administer 50 mg of diamorphine over 24 hours. This has been made up in solution and the syringe filled up to 48 mm. The rate set is **48**.

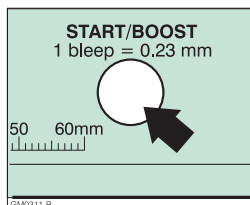

For every mm the syringe plunger moves forwards the patient receives approximately 1 mg (50 mg ÷ 48 mm) of diamorphine.

If the **BOOST** button is pressed long enough for 4 beeps to be counted the plunger will move 4 x 0.23 mm, administering about 1 mg of drug.

Remember that for every mm the plunger is moved forwards by using the **BOOST** button the time to complete the administration will be shortened, by in this example:

$$(1 \div 48) \text{ mm} \times 24 \text{ hours} = 30 \text{ minutes}$$

**Tip:** If boost doses are to be used, allow extra volume in the syringe for these.

## Stopping the Syringe Driver

When the syringe is empty, the Syringe Driver will stop automatically and the alarm will sound for about 15 seconds.

There is no OFF switch to stop the Syringe Driver before the syringe is empty. To stop it; move the rate switches to 00 - the indicator lamp will still flash, or take out the battery.

**Precaution: Risk of the remaining medication flowing out into the patient. Never take a syringe that is not empty off the Syringe Driver and leave it connected to the patient, unless the infusion line is clamped off.**

## Alarms

The Syringe Driver will give an audible alarm lasting about 15 seconds:

- when a battery is put in,
- when the **START/TEST** button on the **MS 16A** is pressed for longer than 5 seconds,
- when the **START/BOOST** button on the **MS 26** is pressed for longer than 10 seconds,
- when the syringe is empty,
- when the Syringe Driver has stopped. This might be caused by a blocked or trapped infusion line.

The indicator lamp will stop flashing:

- when the Syringe Driver has stopped and switched off,
- when the battery needs replacing.

**WARNING: It is essential that the visual and audible alarms on the driver are not obscured so that all alarms are responded to promptly. Failure to respond promptly to an alarm may result in patient injury or death.**

## Accessories

These accessories are supplied with the Syringe Driver:

|                            |  |
|----------------------------|--|
| Cover<br>0105-0529         | A clear rigid plastic cover to put over the Syringe Driver and syringe to protect them.                                |
| Holster<br>0105-0027       | A washable soft fabric holster for carrying the Syringe Driver (with Cover) whilst it is administering the medication. |
| Rate Adjuster<br>0113-0023 | Tool to turn the slotted rate switches.  |

These are the optional accessories which can be ordered:

|                                 |   |
|---------------------------------|---|
| Non-Slip Base<br>0105-0108      | This provides a secure base to stand the Syringe Driver on a flat surface. The Cover is not used with this accessory.                 |
| Instruction manual<br>0105-0549 | Extra copies of this manual can be ordered by quoting this number.  |
| Lockbox<br>0105-0640            | A lockable, translucent box to provide syringe tamper-proofing (supplied with two keys).  |
| Lockbox key<br>0151-0142        | Additional key for the Lockbox.   |
| Training Pack<br>TPF-00130      | A full package of Presentation, Instruction and Testing materials. This material is also available on a CD ROM, part number 0105-0676 |
| Rate Adjuster<br>0105-0623      | Tool to turn the slotted rate switches - with graduations supplied on a keyring   |

## Care and Maintenance

When used as described in these instructions, the Syringe Driver does not require any routine maintenance apart from replacing the battery and occasional cleaning.

It is recommended that the performance of the Syringe Driver is checked annually. If the Syringe Driver is damaged in any way, the performance must always be checked before it is used again. See the section on servicing for further information.

**WARNING: The driver may only be opened by a suitably qualified engineer. Unauthorised modifications may result in the compromised functioning of the driver, leading to patient or user injury or death.**

## Battery replacement

When the indicator lamp fails to flash, a new battery must be fitted.

The driver uses an IEC 6LR61 battery (9 V, alkaline, PP3 size), e.g. Duracell MN1604.

The use of rechargeable cells are **not** recommended.

Some Duracell type batteries do not fit readily in the battery compartment. The metal casing on the battery can catch and then deform at the rear of the compartment.

**Notes:** The driver is protected against the effects of accidental reverse polarity of the battery.

If the battery fit is too tight, source an alternative brand of 6LR61 alkaline battery.

The battery cannot be changed if the driver is in a lockbox. See *page 20* for removal instructions.

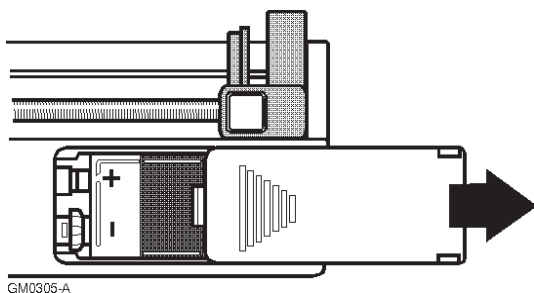

1. Slide off the battery compartment cover at the back of the driver.
2. Turn the driver upside down and carefully tap the driver into the hand to eject the old battery. Dispose of the old battery in accordance with local regulations.

3. Insert the rear end of a new battery into the battery compartment, ensuring correct polarity (refer to the illustration inside the battery compartment).  
Firmly push down the battery contact end.
4. Replace the battery compartment cover, ensuring that it snaps into place when closed.

The alarm will sound for about 15 seconds after the battery is fitted.

**WARNING: Ensure that the correct battery type is fitted, correctly installed and with adequate charge for the infusion. Failure to do so may lead to impaired functioning of the driver, resulting in patient injury or death.**

## Cleaning

**WARNING: Following a significant liquid spill onto the driver, it should be withdrawn from use, wiped dry and inspected and tested by service personnel before being returned to service. Failure to do so may result in compromised functioning of the driver, leading to patient or user injury or death.**

Outside surfaces can be cleaned by wiping them with a soft cloth either dampened with a solution of mild detergent or disinfectant, in water. The threads of the screw the actuator moves along can be cleaned with a small stiff bristled brush. A toothbrush is ideal.

Cleaning with organic solvents, e.g. surgical spirit, or abrasive cleaners, may damage some of the plastic parts.

**Precaution: Risk of change in device performance. Never dip or immerse the Syringe Driver in any liquid or try to sterilize it with steam or gas. It is not completely sealed.**

## Storage

If you are going to store the Syringe Driver for some time, remove the battery and then put it in a warm dry place.

## Servicing

The Syringe Driver must be repaired by either Smiths Medical's service organisation, its appointed representatives or appropriately trained technicians who have access to the correct technical manuals, service bulletins and approved replacement parts.

**WARNING: Failure to follow the Maintenance and Test Procedures described the Graseby MS 16A and MS 26 Syringe Driver Technical Service Manual may result in compromised function of the product and lead to patient injury or death.**

For after-sales service or advice on how to use the Syringe Driver, you can contact customer services at the address on the back cover of the manual.

It will help to quote the Syringe Driver's serial number. This is on the label inside the battery compartment.

### **Disposal (EU Countries)**

Under the Waste Electrical and Electronic Equipment (WEEE) Directive 2006/96/EC and implementing regulations, all devices and service items within the scope of the Directive purchased new after August 13, 2005 must be sent for recycling when ultimately becoming waste. Devices and items must not be disposed of with general waste.

If purchased before that date, they may also be sent for recycling if being replaced on a one-for-one, like-for-like basis (this varies depending on the country).

Recycling instructions to customers using Smiths Medical products are published on the internet at:

**<http://www.smiths-medical.com/recycle>**

### **Disposal (other Countries)**

When disposing of the pump, its batteries or any of its accessories, ensure that any negative impact on the environment is minimised. Contact your local waste disposal service and use local recycling or disposal schemes. Separate any other parts of the equipment where arrangements can be made for their recovery; either by recycling or energy recovery. The main batteries are potentially harmful and will require separate disposal according to manufacturer's instructions or local regulations.

**Note:** If applicable, EU, national or local regulations concerning waste disposal must take precedence over the above advice.

### **Troubleshooting**

If the Syringe Driver does not perform as expected, if it is dropped, gets wet or is damaged in any way, then remove it from use immediately. Mark it clearly as quarantined and preferably take it out of the working area altogether, so it cannot be accidentally used again, until it has been checked. Before it is used

again, it must be carefully inspected for damage inside and its performance checked to the specification. The work must be done by a properly trained technician familiar with how these devices work.

**Precaution: Risk of change in device performance. If the Syringe Driver gets wet do not just dry the outside and then continue to use it. Liquid may have got inside and damaged it. Follow the advice given above.**

| Fault   | Possible cause  | Action  |
|---|---|---|
| The Syringe Driver will not start.                          | The START button has not been pressed in enough.<br>There is no battery.<br>The battery is in the wrong way round.<br>The battery is exhausted.<br>The Syringe Driver is faulty.  | Press again.<br><br>Fit a battery.<br>Refit battery.<br>Fit a new battery.<br>Service needed.   |
| The infusion is going too quickly or has ended early.       | Wrong rate set.<br><br>Wrong syringe brand or size.<br>Syringe plunger push-button or finger grips were not held in the actuator or case correctly.<br>Plunger position measured wrongly.<br>Line was filled after the plunger position was measured.<br>MS 16A being used but the rate set was calculated for an MS 26.<br>Boost button (on MS 26) has been used.<br>Syringe Driver has got wet. | Correct error.<br><br>Correct error.<br>Correct error.<br><br>Correct error.<br>Correct error.<br><br>Recalculate rate for MS 16A.<br>-<br>Remove from use immediately. |
| The infusion is going too slowly.                           | Wrong rate set.<br><br>Wrong syringe brand or size.<br>Plunger position measured wrongly.   | Correct error.<br><br>Correct error.<br>Correct error.  |
| The Syringe Driver has stopped before emptying the syringe. | Exhausted battery.<br>Blocked or trapped infusion line.   | Fit a new battery.<br>Clear line.   |
| The Syringe Driver has stopped with the lamp still flashing | The mechanism for pushing the plunger has worn out. Listen for a faint click when the motor turns a few times.  | Service needed.   |

## 2 Guide to subcutaneous analgesia

### Parenteral administration of drugs

#### Indications

The main indications are the inability to swallow or absorb drugs.

They may be due to:

- Intestinal obstruction,
- mouth, throat and oesophageal lesions,
- persistent nausea and vomiting,
- weakness or unconsciousness,
- malabsorption.

Continuous subcutaneous infusion (CSI), where the drug is slowly infused under the skin, is a method of symptom control that can provide relief of multiple symptoms through one route. It has the following benefits over regular intramuscular injections:

- The variation in plasma concentration levels between injections is reduced.
- It can reduce the cumulative amount of drug required.
- Four hourly injections are avoided. These can be unpleasant and also may be difficult to arrange in the home.
- Patient mobility is maintained.

### Converting from oral to parenteral administration

A loading dose equivalent to a four hourly dose can be given intramuscularly or subcutaneously as the syringe driver is started. This will avoid any lag period during which adequate blood levels are attained.

### Drugs commonly administered using syringe drivers

#### (Opioid) Narcotic Analgesics

|                  |  |
|------------------|--|
| diamorphine      | analgesic used because of its higher solubility in water |
| fentanylmorphine | in the form of the sulphate or hydrochloride             |

#### Anti-emetics, antinauseants and antipsychotics

|                   |  |
|-------------------|--|
| cyclizine         | antinauseant and antihistamine   |
| droperidol        | antinauseant and alternative to haloperidol  |
| haloperidol       | antinauseant, antipsychotic and anxiolytic   |
| hyoscine          | antinauseant, antispasmodic and dries bronchial secretions                               |
| methotrimeprazine | antinauseant and antipsychotic (the solution should be isotonic to avoid skin reactions) |
| metoclopramide    | anti-emetic and antinauseant   |



chlorpromazine, diazepam and prochlorperazine should be avoided as they cause skin irritation.

### **Corticosteroids**

dexamethasone                      anti-inflammatory (mix with caution to avoid precipitation)

Some of these drugs can be administered in mixtures but care must be taken to make sure they are compatible and to avoid problems with precipitation and crystallisation if infusions are to last longer than 24 hours.

### **What is needed for a subcutaneous infusion with the Syringe Driver?**

- 9 V 'alkaline' battery
- Syringe Driver Cover
- Holster (for mobile patient)
- Rate adjusting key or small flat-bladed screwdriver
- Syringe (any brand and chosen size that can be fitted safely onto the Syringe Driver)
- Infusion set
- Antiseptic treated wipe
- Clear surgical dressing
- Surgical adhesive tape
- Transfer needle for filling syringe with medication from container
- Drugs
- Diluent if required.

A subcutaneous infusion pack, *part number 0105-0117*, is available from Smiths Medical, which includes the following sterile items:

- 1 10 ml syringe
- 1 Transfer needle 0.8 mm (21G/green)
- 1 Infusion set, 100 cm long with 0.5 mm (25G) 'winged' needle
- 1 Alcohol saturated wipe
- 1 Clear surgical dressing, approximate size 6 cm x 7 cm

If a 30 ml Luer lock syringe is required, order *part number 0105-0881*.

## Selection of a suitable infusion site

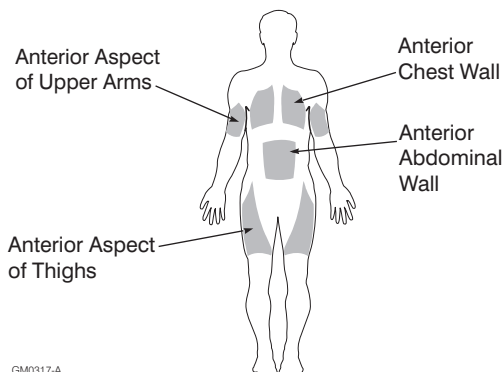

GM0317-A

If possible discuss with the patient the preferred method of carrying the Syringe Driver before selecting the infusion site. Areas of oedema, swollen tissue, are not suitable for CSI as drug absorption may not be effective. Avoid the upper arm site in bedbound patients who require turning at regular intervals.

Check the site regularly to make sure the skin tissue is not inflamed or infected. If this occurs, a new infusion set should be used with the needle sited at least 3 cm away from the problem site.

## Inserting the Subcutaneous Needle

1. Clean the skin with a swab or antiseptic wipe.
2. Avoid touching the needle itself. Hold it by the wings and insert it at an angle to the skin, then lay it flat. Lifting a fold of skin between the finger and thumb may ease insertion.  
**Precaution: Do not bend the needle as this will weaken it and a piece may break off in the patient.**
3. Loop some of the tubing over the wings of the needle and stick it down with some surgical adhesive tape. This helps keep any tension from pulling the needle out of the site.
4. Cover the site with a clear surgical dressing.

## Observation during treatment

1. Assess symptom control, preferably four to six hours after starting treatment. Then daily or when the syringe is changed whichever is sooner.
2. Check the infusion site for irritation, inflammation, infection and needle displacement.
3. Check the syringe and infusion set for precipitation or crystallisation of the medication.
4. Check for leakage at the site and at the syringe to infusion set connection.
5. Check the Syringe Driver for an exhausted battery, the wrong rate setting and for physical damage. Also see **During the administration.**

### 3 Technical and Performance Specification

**Type:**

Syringe driver with motor driven linear actuator, pulsed motion.  
Internal low voltage power source. Digital electronic rate control.  
Automatic switch off when syringe is empty.

**Rate range:**

MS 16A 0 - 99 mm/ h in steps of 1 mm/ h  
MS 26 0 - 99 mm/24 h in steps of 1 mm/24 h

**Drive accuracy:**

+/- 5%

**Motor operating interval:**

MS 16A (420 ÷ Rate) seconds  
MS 26 (168 ÷ Rate) minutes

**Actuator movement:**

0.12 mm every time motor turns

**Actuator stroke:**

60 mm available

**Syringe sizes:**

2 ml to 35 ml

**Occlusion pressure:**

Dependent on syringe size (internal diameter)  
Maximum actuator force 50 N (5 kgf)

**Controls:**

START (and TEST [MS 16A] or BOOST [MS 26]), Rate ('tens' and 'units' digits)

**Alarm:**

Audible, 3 kHz

**Indicator:**

Yellow solid state lamp

**Battery:**

9 V, primary alkaline, IEC 6LR61 (or 6LF22) type

**Battery life:**

50 full deliveries depending on operating conditions

**Size:**

166 x 53 x 23 mm without a syringe or Cover  
240 x 95.5 x 38 mm with Lockbox

**Weight:**

185 grams including battery  
261 grams including battery and cover  
183 grams Lockbox only

**Operating conditions:**

+10° C - +40° C, 30% - 75% RH (non-condensing),  
700 hPa - 1060 hPa

**Transport and Storage conditions:**

-40° C - +70° C, 10% - 100% RH (non-condensing),  
500 hPa - 1060 hPa

**Materials:**

Case - ABS, Cover and labels - PC, other small plastic parts - POM (acetal) and PA-GF (glass-filled nylon), metal parts - stainless steel, circuit board - epoxy glass fabric.

**Note:** All materials used in this product are latex free.

**EMC Guidance and Manufacturer's Declarations:**

| <b>Guidance and manufacturer's declaration – electromagnetic emissions</b>   |                       |   |
|--|-----------------------|---|
| The Graseby Syringe Driver MS16A and MS26 are intended for use in the electromagnetic environment specified below. The customer or the user of the Graseby Syringe Driver MS16A and MS26 should assure that it is used in such an environment. |                       |   |
| <b>Emissions test</b>  | <b>Compliance</b>     | <b>Electromagnetic environment – guidance</b>   |
| RF emissions<br>CISPR 11   | Group 1               | The Graseby Syringe Driver MS16A and MS26 uses RF energy for its internal function. Therefore, its RF emissions are very low and are not likely to cause any interference in nearby electronic equipment.   |
| RF emissions<br>CISPR 11   | Class B               | The Graseby Syringe Driver MS16A and MS26 is suitable for use in all establishments, including domestic establishments and those directly connected to the public low-voltage power supply network that supplies buildings for domestic purposes. |
| Harmonic Emissions<br>IEC 61000-3-2  | Complies <sup>1</sup> |   |
| Voltage fluctuations/<br>flicker emissions<br>IEC 61000-3-2  | Complies <sup>1</sup> |   |

<sup>1</sup>Compliance assumed as there is no mains power connection to the Graseby Syringe Driver MS16A and MS26

**Guidance and manufacturer's declaration – electromagnetic immunity**

The Graseby Syringe Driver MS16A and MS26 are intended for use in the electromagnetic environment specified below. The customer or the user of the Graseby Syringe Driver MS16A and MS26 should assure that it is used in such an environment.

| <b>Immunity test</b>   | <b>IEC60601 test level</b>  | <b>Compliance</b>           | <b>Electromagnetic environment – guidance</b>  |
|--|---|-----------------------------|--|
| Electrostatic discharge (ESD)<br>IEC 61000-4-2   | ±6 kV contact<br>±8 kV air  | ±8 kV contact<br>±15 kV air | Floors should be wood, concrete or ceramic tile. If the floors are covered with synthetic material the relative humidity should be at least 30% (minimum operating humidity for the pump). |
| Electrical fast transit/burst<br>IEC 61000-4-4   | ±2 kV for power supply lines<br>±1 kV for input/output lines  | Not applicable              | Not applicable   |
| Surge<br>IEC 61000-4-5   | ±1 kV line(s) to line(s)<br>±2 kV line(s) to earth  | Not applicable              | Not applicable   |
| Voltage dips, short interruptions and voltage variations on power supply input lines<br>IEC 61000-4-11 | <5% $U_T$<br>(>95% dip in $U_T$ )<br>for 0,5 cycle<br>40% $U_T$<br>(60% dip in $U_T$ )<br>for 5 cycles<br>70% $U_T$<br>(30% dip in $U_T$ )<br>for 25 cycles<br><5% $U_T$<br>(>95% dip in $U_T$ )<br>for 5 sec | Not applicable              | Not applicable   |
| Power frequency (50/60 Hz) magnetic field<br>IEC 61000-4-8   | 3 A/m   | 400 A/m                     | The higher compliance level recognises the higher magnetic fields present in some areas of the hospital environment, e.g. operating theatres where diathermy is used.                      |

**Note:**  $U_T$  is the A.C. mains voltage prior to the application of the test level

**Guidance and manufacturer's declaration – electromagnetic immunity**

The Graseby Syringe Driver MS16A and MS26 are intended for use in the electromagnetic environment specified below. The customer or the user of the Graseby Syringe Driver MS16A and MS26 should assure that it is used in such an environment.

| Immunity test                 | IEC60601 test level         | Compliance     | Electromagnetic environment – guidance  |
|-------------------------------|-----------------------------|----------------|---|
| Conducted RF<br>IEC 61000-4-6 | 3 Vrms<br>150 kHz to 80 MHz | Not applicable | <p>Portable and mobile RF communications equipment should be used no closer to any part of the Graseby Syringe Drivers, models MS16A and MS26, including cables, than the recommended separation distance calculated from the equation applicable to the frequency of the transmitter.</p> <p>Recommended separation distance</p> <p>Not applicable</p>   |
| Radiated RF<br>IEC 61000-4-3  | 3 V/m<br>80 MHz to 2.5 GHz  | 10 V/m         | <p><math>d = 0.35\sqrt{P}</math> 80 MHz to 800 MHz</p> <p><math>d = 0.7\sqrt{P}</math> 800 MHz to 2.5 GHz</p> <p>where <math>P</math> is the maximum output power rating of the transmitter in watts (W) according to the transmitter manufacturer and <math>d</math> is the recommended distance in metres (m).</p> <p>Field strength from fixed RF transmitters, as determined by the by an electromagnetic site survey, <sup>a</sup> should be less than the compliance level in each frequency range. <sup>b</sup></p> <p>Interference may occur in the vicinity of equipment marked with the following symbol:</p>  |

**Guidance and manufacturer's declaration – electromagnetic immunity**

**Note 1:** At 80 MHz and 800 MHz, the higher frequency range applies

**Note 2:** These guidelines may not apply in all situations. Electromagnetic propagation is affected by adsorption and reflection from structures, objects and people

a. Field strengths from fixed transmitters, such as the base stations for radio (cellular/cordless) telephones and land mobile radios, amateur radio, AM and FM radio broadcast cannot be predicted theoretically with accuracy. To assess the electromagnetic environment due to fixed RF transmitters, an electromagnetic site survey should be considered. If the measured field strength in the location in which the Graseby Syringe Drivers, models MS16A and MS26 is used exceeds the applicable RF compliance level above, the Graseby Syringe Drivers, models MS16A and MS26 should be observed to verify normal operation. If abnormal performance is observed, additional measures may be necessary, such as re-orientating or relocating the Graseby Syringe Drivers, models MS16A and MS26.

b. Over the frequency range 150 kHz to 80 MHz, field strengths should be less than 10V/m.

**Recommended separation distances between portable and mobile RF communications equipment and the Graseby Syringe Drivers, models MS16A and MS26**

The Graseby Syringe Drivers, models MS16A and MS26 are intended for use in the electromagnetic environment in which radiated RF is controlled. The customer or the user of the Graseby Syringe Drivers, models MS16A and MS26 can help prevent electromagnetic interference by maintaining a minimum distance between portable and mobile RF communications equipment (transmitters) and the Graseby Syringe Drivers, models MS16A and MS26 as recommended below, according to the maximum output power of the communications equipment.

| Rated maximum output power of transmitter<br>W | Separation distance according to frequency of transmitter<br>m |   |   |
|--|--|---|---|
|  | 150 kHz to 80 MHz<br>Not applicable                            | 80 MHz to 800 MHz<br>$d = 0,35\sqrt{P}$ | 800 MHz to 2.5 GHz<br>$d = 0,7\sqrt{P}$ |
| 0,01   | -  | 0,04                                    | 0,07                                    |
| 0,1  | -  | 0,11                                    | 0,22                                    |
| 1  | -  | 0,35                                    | 0,7                                     |
| 10   | -  | 1,1                                     | 2,2                                     |
| 100  | -  | 3,5                                     | 7                                       |

For transmitters rated at a maximum output power not listed above, the recommended separation distance  $d$  in metres (m) can be estimated using the equation applicable to the frequency of the transmitter, where  $P$  is the maximum output power rating in watts (W) according to the transmitter manufacturer.

**Note 1:** At 80 MHz and 800 MHz, the higher frequency range applies

**Note 2:** These guidelines may not apply in all situations. Electromagnetic propagation is affected by adsorption and reflection from structures, objects and people

**Medical Device Directive 93/42/EEC:**

CE marked under Annex II, risk class IIb (active medical device).  
Notified Body: AMTAC (0473).

**Compliant standards:**

IEC 60601-1:1998, EN 60601-1:1998, IEC 60601-1-2:2001,  
EN 60601-1-2:2002

RTCA DO-160D [RTCA (the Radio Technical Commission for  
Aeronautics)]

Tests have confirmed that the MS16A and MS26 (Syringe Drivers)  
pumps function correctly within a commercial aircraft that has a  
controlled pressurised cabin area which maintains the cabin pressure  
at normal comfort levels.



## Standards

### CE Marking

The CE mark demonstrates that the Monitor conforms to the requirements in the European Council Directives 93/42/EEC concerning medical devices. The number 0473 identifies the Notified Body under which the Quality Systems operated within Smiths Medical are assessed.

### Disposal (EU Countries)



Under the Waste Electrical and Electronic Equipment (WEEE) Directive 2006/96/EC and implementing regulations, all devices and service items within the scope of the Directive purchased new after August 13, 2005 must be sent for recycling when ultimately becoming waste. Devices and items must not be disposed of with general waste.

If purchased before that date, they may also be sent for recycling if being replaced on a one-for-one, like-for-like basis (this varies depending on the country).

Recycling instructions to customers using Smiths Medical products are published on the internet at:

**<http://www.smiths-medical.com/recycle>**

### Disposal (other Countries)



When disposing of the pump, its batteries or any of its accessories, ensure that any negative impact on the environment is minimised. Contact your local waste disposal service and use local recycling or disposal schemes. Separate any other parts of the equipment where arrangements can be made for their recovery; either by recycling or energy recovery. The main batteries are potentially harmful and will require separate disposal according to manufacturer's instructions or local regulations.

**Note:** If applicable, EU, national or local regulations concerning waste disposal must take precedence over the above advice.

## Packaging symbols



Temperature limitation. Values show upper and lower limit of temperature (°C).



Humidity limitation. Values show upper and lower limits of humidity (%).



Atmospheric pressure limitation. Values show upper and lower limits of atmospheric pressure (kPa).





For further information, please contact your local distributor or  
Smiths Medical direct on +44 (0)1923 246434

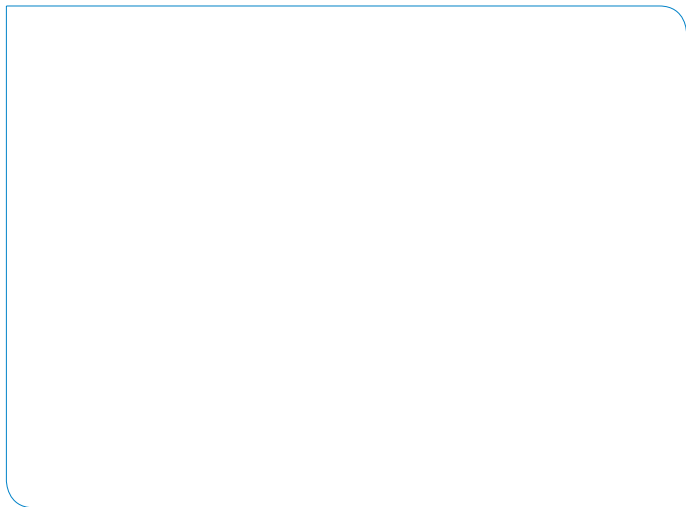

**Smiths Medical MD, Inc.**

1265 Grey Fox Road, St Paul, MN 55112, U.S.A.

European Representative:

**Smiths Medical International Limited**

Watford, Hertfordshire, UK, WD24 4LG

[www.smiths-medical.com](http://www.smiths-medical.com)

**Smiths Medical - part of the global technology business Smiths Group**

© 2008 Smiths Medical family of companies.

All rights reserved.

Revision issue date: May 2008

Part No. 0105-0549-106



**smiths medical**